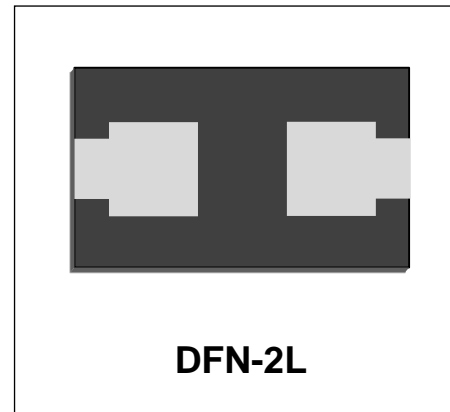

Transient Voltage Suppressor**Features**

- Small Body Outline Dimensions:
0.039" x 0.024" (1.0 mm x 0.60 mm)
- Protects one I/O or power line
- Low Clamping Voltage
- Ultra Low Capacitance:1.5pF
- Working Voltage: 5 V
- Low Leakage Current
- Response Time is Typically < 1 ns

**IEC COMPATIBILITY (EN61000-4)**

- IEC 61000-4-2 (ESD) $\pm 15\text{kV}$ (air), $\pm 8\text{kV}$ (contact)
- IEC 61000-4-4 (EFT) 40A (5/50ns)

Mechanical Characteristics

- DFN-2L package
- Molding compound flammability rating:
UL 94V-0
- Marking: Marking Code
- Packaging: Tape and Reel per EIA 481
- RoHS/WEEE Compliant

Applications

- Laptop Computers
- Cellular Phones
- Digital Cameras
- Personal Digital Assistants (PDAs)

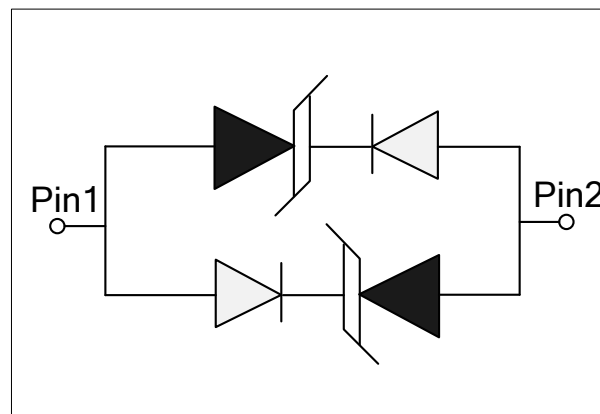
Schematic & PIN Configuration

Absolute Maximum Rating			
Rating	Symbol	Value	Units
Electrostatic discharge Voltage (See Note1 ,2)	V_{ESD}	8KV (contact)	Volts
		15KV (air)	
Operating Temperature	T_J	-55 to + 125	°C
Storage Temperature	T_{STG}	-55 to +150	°C

Electrical Parameters (T=25°C)

Symbol	Parameter
I_{PP}	Maximum Reverse Peak Pulse Current
V_C	Clamping Voltage @ I_{PP}
V_{RWM}	Working Peak Reverse Voltage
I_R	Maximum Reverse Leakage Current @ V_{RWM}
V_{BR}	Breakdown Voltage @ I_T
I_T	Test Current
I_F	Forward Current
V_F	Forward Voltage @ I_F

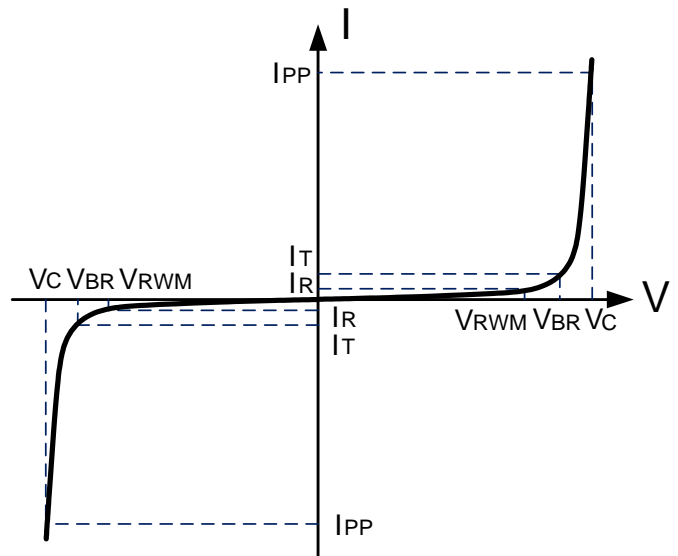

Electrical Characteristics

KJESD05DLCF-B						
Parameter	Symbol	Conditions	Minimum	Typical	Maximum	Units
Reverse Stand-Off Voltage	V_{RWM}				5.0	V
Reverse Breakdown Voltage	V_{BR}	$I_T=1mA$	6.0			V
Reverse Leakage Current	I_R	$V_{RWM}=5V, T=25^\circ C$			1	μA
Clamping Voltage	V_C	$I_{PP}=1A, t_p=8/20\mu s$		8.5	12.5	V
Junction Capacitance	C_j	$V_R = 0V, f = 1MHz$		1.5	2.5	pF

Note1: ESD Pulse Waveform according to IEC 61000-4-2. see Table1 and Figure4.

Note2: ESD tests Setup see Figure 5.

Typical Characteristics

Figure 1: Power Derating Curve

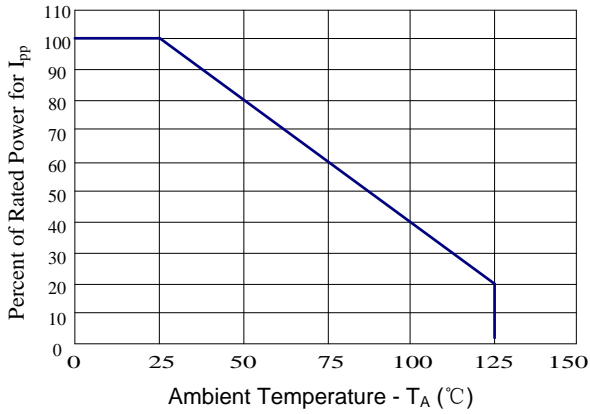

Figure 2: Insertion Loss

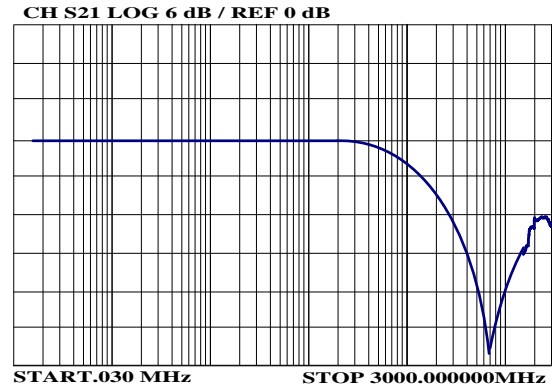

Figure 3: Normalized Junction Capacitance vs. Reverse Voltage

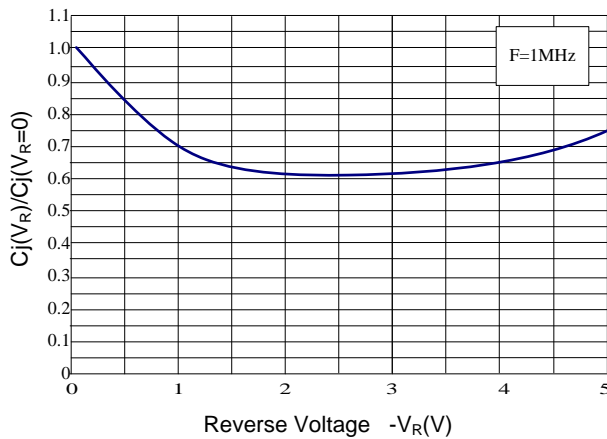

Table 1. IEC 61000-4-2 Discharge Parameters

Level	First Peak Current (A)	Peak Current at 30 ns (A)	Peak Current at 60 ns (A)	Test Voltage (Contact Discharge) (kV)	Test Voltage (Air Discharge) (kV)
1	7.5	4	2	2	2
2	15	8	4	4	4
3	22.5	12	6	6	8
4	30	16	8	8	15

Figure 4. IEC 61000-4-2 Waveform

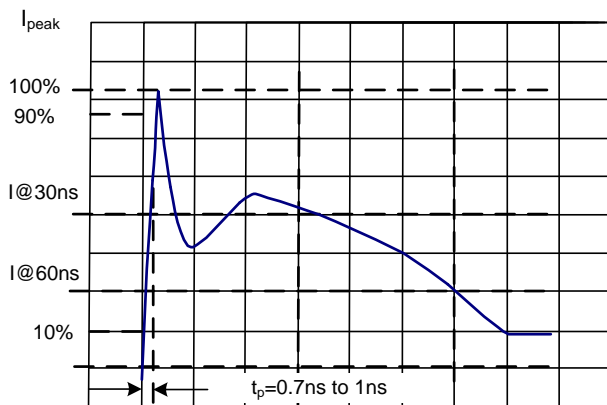
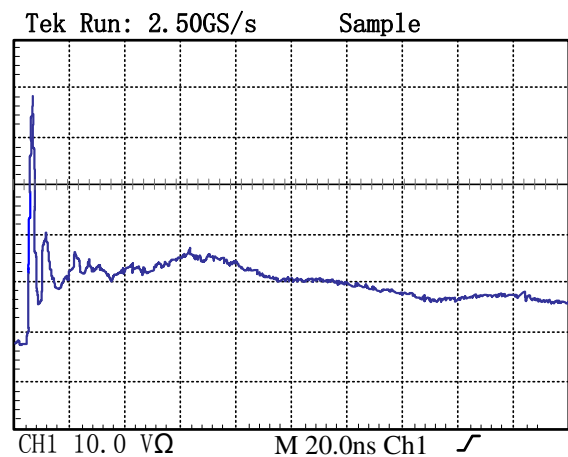
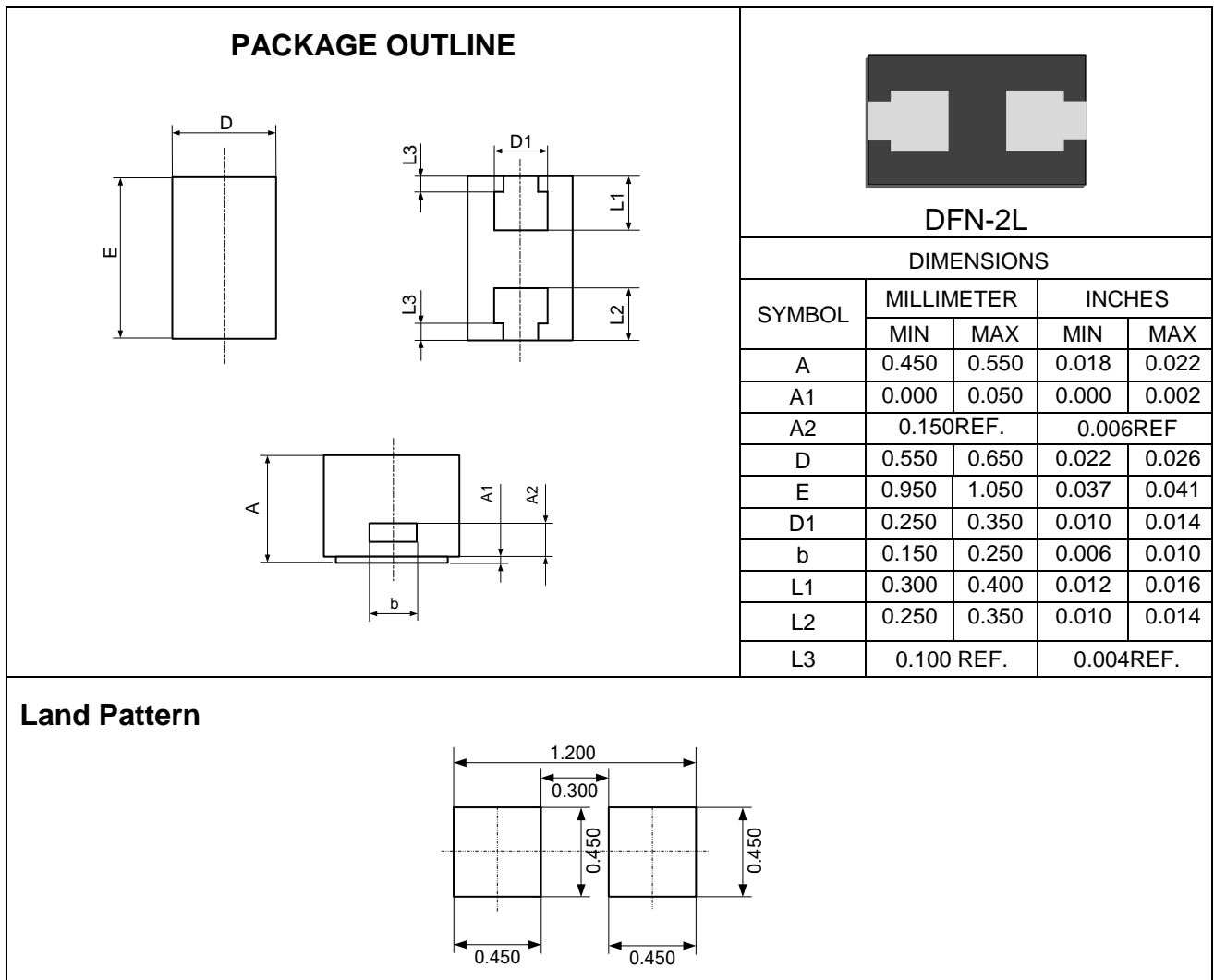

Figure 5: ESD Clamping(8kV Contact per IEC 61000-4-2)



Outline Drawing –DFN-2L

Marking Codes

Part Number	Marking Code
KJESD05DLCF-BL	<div style="border: 1px solid black; padding: 5px; display: inline-block;">V B</div>